

ABU Asia-Pacific Robot Contest 2022

New Delhi, India



LAGORI

~The ABU Robocon 21st Game~

Theme and Rules

ABU Asia-Pacific Robot Contest 2022 New Delhi, India

Host Organizing Committee

<http://www.aburobocon2022.com>

September 2022

Background of the game

Lagori is a traditional and one of the most played ancient games that originate in the southern part of India. It was one of the most popular game in India around the 1990s. One can find the game history in Bhagavata Purana, Hindu religious text written around 5000 years ago. It mentions that Lord Krishna played this game with his friends. The game is between two teams (Team 1: “Seeker” and Team 2: “Hitter”) and the game starts by throwing a ball by the seeker to break a stone tower called “Lagori” (see figure below). While the seekers try to pile up the stones again, the hitter throws balls to interrupt them.



In 2022, ABU Robocon meets its 21st birthday. Will the Lagori be piled up successfully? Or will they be attacked before achieving it? Let the exciting game of Lagori begin! We look forward to seeing the performance of robots built by young engineers in New Delhi, India.

Importance of Safety

Safety is one of the essential elements in the sustainable development of the ABU Robocon.

The safety of the designed robots is the first and foremost issue for the safety principle of the contest. The participating teams, as the robot designers, are responsible for the safety of their robots. Safety must always be the top priority and must be considered by all people involved in the contest, including officials, participants and spectators in all circumstances. The teams must work and cooperate closely with the organizers to ensure the utmost safety of the competition.

Teams are required to pay sufficient attention to the safety of their robots before applying to take part in the contest. Safety in the performance of robots must be visible both to the naked eye and the cameras. One should easily observe whether the designed robots meet the safety requirements during the video check and test runs.

Please attach the actual emergency button on the robots. Team members must take care of their safety apart from the robot's safety.

Contest Outline

Title: ABU Asia-Pacific Robot Contest 2022 New Delhi, India
(Alias: ABU Robocon 2022 New Delhi)

Organizer: ABU (Asia-Pacific Broadcasting Union)

Host: ABU Asia-Pacific Robot Contest 2022, New Delhi, India Host Organizing Committee (Doordarshan)

Contest Date: Sunday, 21 August 2022

Contest Venue: Tyagraj Stadium, New Delhi, India

Schedule:

Friday, 19 August	Participants' Arrival
Saturday, 20 August	Orientation, Test-run, Rehearsal
Sunday, 21 August	Contest Day
Monday, 22 August	Friendship Exchange Programme, ABU Robocon Meeting
Tuesday, 23 August	Participants' Departure

Theme and Rules: LAGORI**Competition Method:** Preliminary League and Final Tournament**Participants:** To be confirmed in July 2022

Awards: ABU Robocon award, Grand Prix, 1st runner-up, 2nd Runner-ups, Best Idea Award, Best Engineering Award, Best Design Award, Special Awards

Outline of the Lagori Game for ABU Robocon 2022

- A) Each team must build two Robots (Robot 1, Robot 2).
- B) There are 2 Rounds (1st Round, 2nd Round) per game.
- C) The referee will give each team the role of Seeker or Hitter. The role will reverse for each Round, i.e., in the 1st Round, the Red Team will be Seeker and the Blue Team will be Hitter. In the 2nd Round, the Red Team will be Hitter and the Blue Team will be Seeker.
- D) When the Round starts, Seeker will throw balls to break the Lagori discs and pile them up in the original order. The team will get points according to the number of broken Lagori discs and the piled-up Lagori discs.
- E) Hitter throws balls to prevent Seeker from piling up Lagori discs.

Name and role of the robots

	Red Team	Robot 1	Robot 2	Blue Team	Robot 1	Robot 2
1 st Round	Seeker	Seeker R1	Seeker R2	Hitter	Hitter R1	Hitter R2
2 nd Round	Hitter	Hitter R1	Hitter R2	Seeker	Seeker R1	Seeker R2

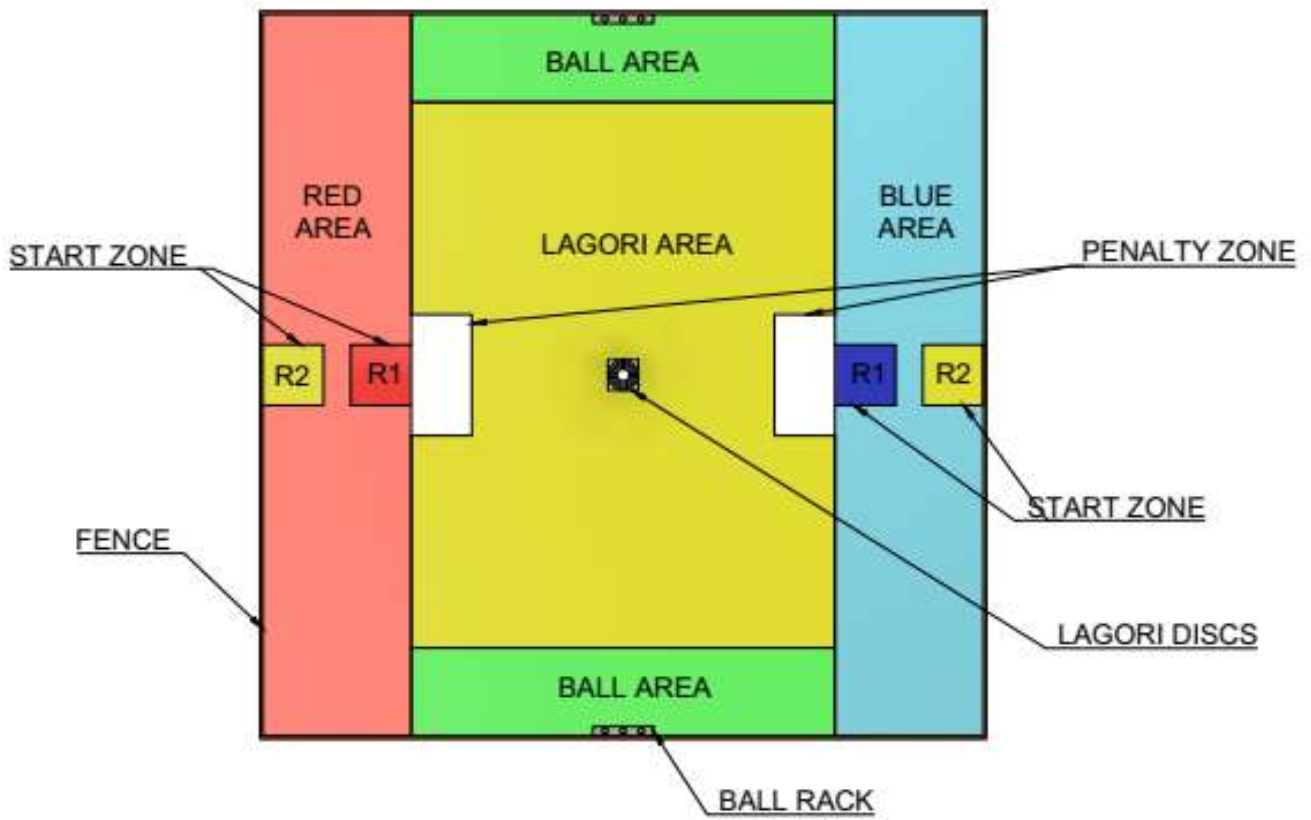

Fig. 1 Game Field and Its Function Areas

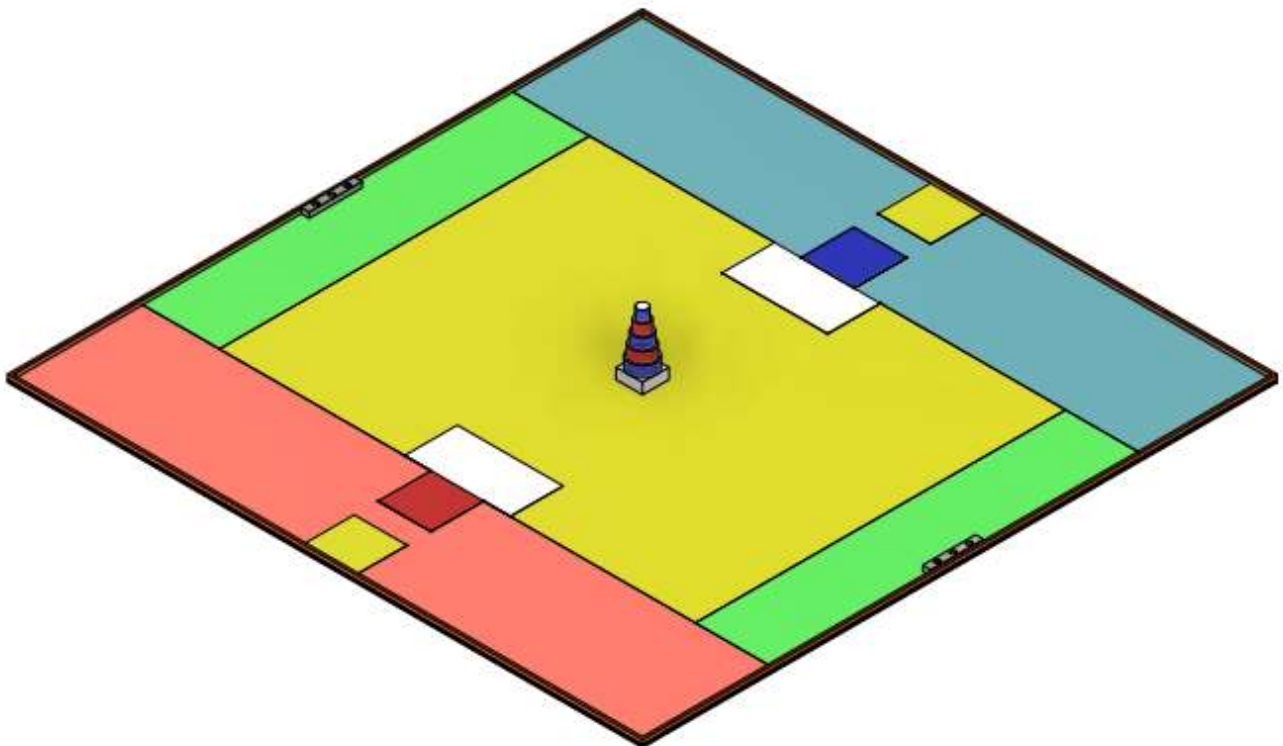

Fig. 2 Game Field (Perspective View)

Game Rules

1. Terms and Definitions

Terms and definitions used in the rules of ABU Robocon 2022 New Delhi are as follows:

S. No.	Term	Definition
1.1	Team	Two teams will be called Red Team and Blue Team.
1.2	Robot	Each team must build two robots, namely, Robot 1 and Robot 2. The robots can be manual or automatic.
1.3	Seeker	The referee will give this role to the Red Team in the 1st Round and the Blue Team in the 2nd Round. Seeker R1 throws Balls from R1SZ to break the Lagori. Seeker R2 piles up broken Lagori discs in the Lagori Area. A ball will be placed on top of Seeker R2 (Ball on Head) before the round begins.
1.4	Hitter	The referee will give this role to the Blue Team in the 1st Round and the Red Team in the 2nd Round. Hitter R1 and Hitter R2 go to the Ball Area to pick up Balls. Hitter R1 throws them at the ball on top of the Seeker R2 (Ball on Head) to displace it. Hitter R2 can pick up Balls from the Ball Areas and pass them to Hitter R1 without the ball touching the field surface.
1.5	Ball on Head (BH)	Ball on Head is the ball that is carried on top of Seeker R2 during the game. The ball has a diameter of 140 mm and a weight of 200 g (size 1 soccer ball). The Ball on Head must meet the following conditions: ① It must be placed on the pipe and plate as shown in the drawing. (Please see Fig. 3) ② The upper surface of the plate must be fixed at a position ranging from 1200-1250 mm from the field surface. ③ No part of R2 should protrude above the surface of the plate. ④ Each team must make the pipe and plate. The organizer of the contest will provide the ball.
1.6	Game Field	The field where the robots of teams run and complete their tasks. It is a square area sized 12,000 mm and 12,000 mm. See Fig. 1.
1.7	Lagori Area	Lagori Area is where Lagori is placed at the center of the game field (Dimensions of this zone is 9,000 mm × 7,000 mm). During the game, only Seeker R2 can move in this area.
1.8	Red Area	Red Team can move in this area. It has R1 Start Zone and R2 Start Zone. Blue Team cannot enter in this area.
1.9	Blue Area	Blue Team can move in this area. It has R1 Start Zone and an R2 Start Zone. Red Team cannot enter in this area.
1.10	Fence	A fence with a height of 80 mm and a width of 50 mm surrounds the outer circumference of the Game Field. The robot cannot touch the top and outside of the fence, but it can touch the inside of the fence.
1.11	Start Zone (SZ)	The Red Area and Blue Area have four start zones for two robots of each team. The size of all start zones is 1,000 mm × 1,000 mm. Red Area: R1 Start Zone (R1SZ) • R2 Start Zone (R2SZ) Blue Area: R1 Start Zone (R1SZ) • R2 Start Zone (R2SZ)
1.12	Penalty	A zone where a part of the robot must not stay for more than 10

	Zone (PZ)	seconds, including the space above. If it exceeds 10 seconds, it will be a compulsory retry. (Please see Fig. 1)
1.13	Seeker Balls	A ball with a diameter of 140 mm and a weight of 200 g (size 1 soccer ball) for the Seeker to throw and break the Lagori. Team members will load the Seeker Balls to the Seeker R1 during the setting time. Up to 3 balls can be loaded. The balls are to be provided by the organizer of the contest.
1.14	Hitter Balls	A ball with a diameter of 140 mm and a weight of 200 g (size 1 soccer ball) for the Hitter to throw and hit the Ball on Head. A total of 6 Hitter Balls are arranged on the Ball Racks in the Ball Areas. The balls are to be provided by the organizer of the contest.
1.15	Ball Area	There are two Ball Areas in the Game Field, each with three Hitter Balls. Before the Round starts, the balls are placed on the Ball Racks as shown in the separate drawing. Only Hitter can enter these areas.
1.16	Ball Rack	There is a Ball Rack with length of 1,000 mm, width of 150 mm, and height of 100 mm in each Ball Area. Three (3) balls in each, total of 6 balls are arranged in the Ball Racks. Those balls are placed on holes with diameter of 10 cm. The Ball Racks are fixed to the field. (Please see figure No. 0.5)
1.17	Lagori	It is a tower with five (5) cylindrical discs to be placed top of one another on a square base of size (500 mm × 500 mm and 200mm high). The height of each disc is 200 mm. Diameters of the discs are 500 mm (bottom), 425 mm, 350 mm, 275 mm, and 200 mm (top). The material is POLYURETHANE Foam of density 14 kg per meter cubed. Note that “top” and “bottom” surfaces of each disc are uncolated.
1.18	Lagori Break	Seeker R1 breaks the Lagori by throwing the Seeker Ball. Lagori is considered broken if a part of Lagori disc(s) come in contact with the field surface.
1.19	Break Shot Time	The period that Seeker R1 can break the Lagori, which is the first 30 seconds of each Round. If Seeker fails to break any of the Lagori discs within this time, the Round will end.
1.20	Lagori Pile	Seeker R2 collects the broken Lagori discs and pile them up in the original order is called "Lagori Pile". (Please see Fig. 4)
1.21	Perfect Lagori	When Seeker breaks all 5 Lagori discs and piles all of them back successfully.

2. Game

Each Round is 90 secs and the total game time is 3 min.

2.1 Game Procedure

◆ Before the start of the game

2.1.1 Both teams place their robots in their start zone in the field before the Setting Time.

2.1.2 Referee will give the one-minute setting time before each Round starts.

Three team members and a maximum of three pit crews can start setting their robots.

2.1.3 Team members can load up to 3 Seeker Balls on the Seeker R1 during the setting time.

2.1.4 During the setting time, the team will set up the Ball on Head in the Seeker R2.

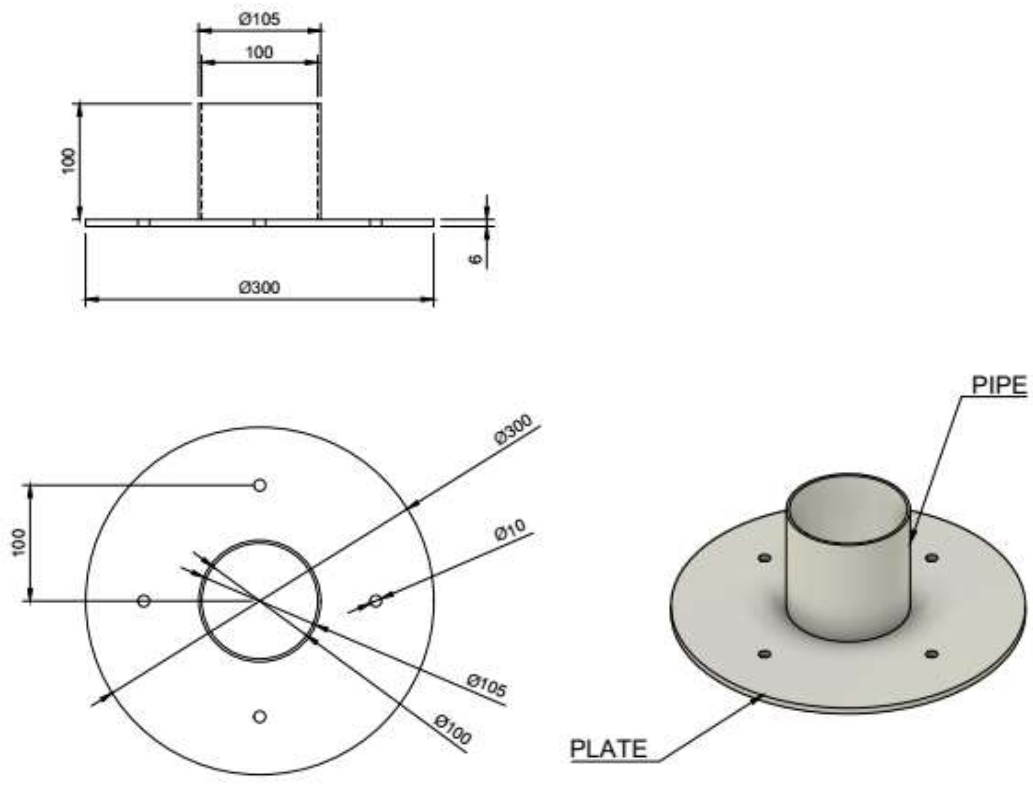

Fig. 3 Ball on Head

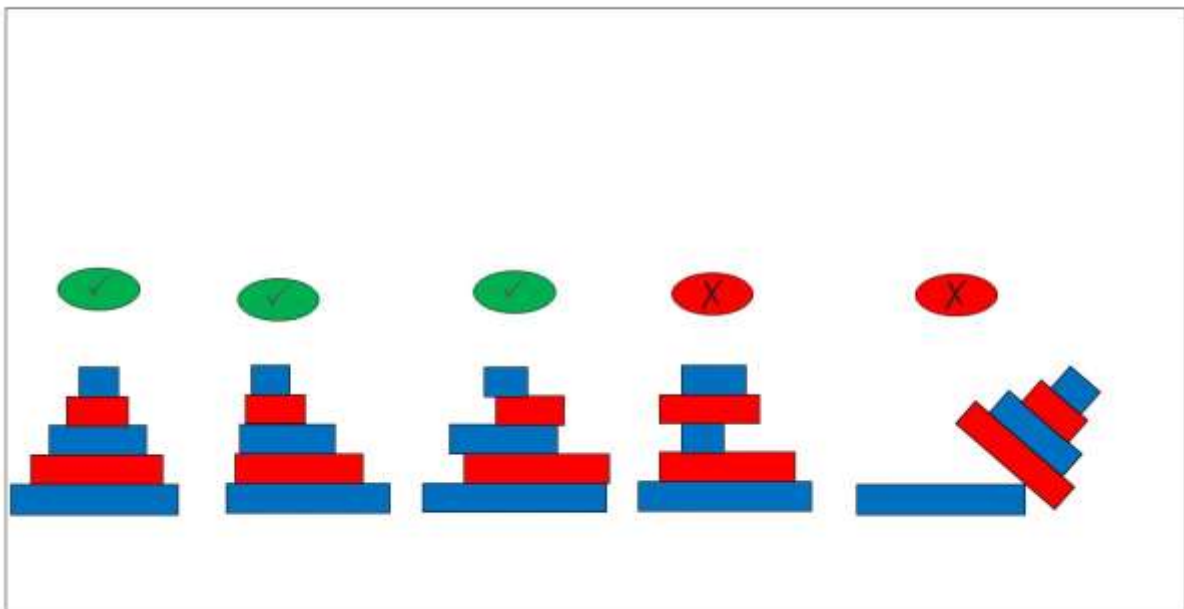

Fig. 4 Lagori Pile

- 2.1.5 If the team fails to complete the setting within the given time, the setting can be resumed after the start of the game. Once the setting is done, the team can start the robot with the referee's permission.
- 2.1.6 Before the game starts, R1 and R2 must be in their respective start zones, including the space above.

◆ During the game

When the Setting Time is over, the game will start with the start of Round 1.

- 2.1.7 Team members must stay outside of the field except when the team members push start buttons of the Robots and retry.
- 2.1.8 Team members must not touch Lagori during the game. (Please refer to 2.5.7 and 2.5.8 for exceptions)
- 2.1.9 Team members must not touch any ball except for a retry during the game.
- 2.1.10 When Round 1 starts, Seeker R1 throws Seeker Balls to break the Lagori. However, Seeker R1 can throw the balls only when all of its contact surfaces with the field are in the R1SZ. The seeker will score points according to the number of broken Lagori discs. Seeker can throw Seeker Balls up to 3 times during the Break Shot Time (30 seconds).
- 2.1.11 When all 5 Lagori discs are broken or the Break Shot Time is finished, after the referee's signal, the Seeker R2 can start piling up the Lagori discs in the remaining time in the Round. The seeker will earn points according to the number of Lagori discs piled up.
- 2.1.12 When all Lagori discs have been broken or the Break Shot Time is finished, after the referee's signal, Hitter's R1 and R2 can start moving to pick up the Hitter Balls
- 2.1.13 Hitter R1 can throw the Hitter Balls at the Ball on Head of Seeker R2 to displace it. Hitter R2 can pick up Hitter Balls from the Ball Areas and pass them to Hitter R1. While passing from Hitter R2 to Hitter R1 the balls should not touch the field surface. Hitter R1 can throw the balls only when all of its contact surfaces with the field are in the R1SZ.
- 2.1.14 Hitter R2 must displace the Ball on Head directly using a Hitter ball. If the Hitter Ball thrown by Hitter R1 does not hit the Ball on Head directly and the Ball on Head is displaced, the Hitter will be forced to retry and cannot restart for 15 seconds. The Seeker team members reset the Ball on Head immediately.
- 2.1.15 A Round ends when one of the following conditions is fulfilled;
 - ① When Seeker finishes "Lagori Pile."
 - ② The Hitter Ball displaces the Ball on Head of Seeker R2.
 - ③ 90 seconds have passed from the start of the Round.
- 2.1.16 When the 1st Round is over, the game will be suspended and both teams must move their robots quickly to their respective Start Zone. Then one minute Setting Time will start immediately. Blue Team which will be the next Seeker, can load up to 3 Seeker Balls to R1. After that, with the referee's signal, the game will restart with Round 2.
- 2.1.17 The game will finish when the 2nd Round is over.

2.2 Tasks of robots

Seeker R1

- 2.2.1 The task of Seeker R1 is "Lagori Break."
- 2.2.2 When the Round starts, R1 throws the Seeker Balls from R1SZ and breaks the Lagori during the 30-second Break Shot Time.
- 2.2.3 When throwing Seeker Balls, the ground plane of the robot must not leave the R1SZ, but it is allowed to extend outside in the space above.
- 2.2.4 Only one Seeker Ball can be thrown at a time. R1 can throw balls continuously, one after the other.
- 2.2.5 "Lagori Break" finishes when one of the following conditions is fulfilled.
 - ① When R1 breaks all the 5 Lagori discs.
 - ② When all the three Seeker Balls have been thrown.
 - ③ When the Break Shot Time is finished.The referee will give signals at the time of ①/②/③ completion.

Seeker R2

- 2.2.6 The task of Seeker R2 is “Lagori Pile.”
- 2.2.7 R2 can leave R2SZ after “Lagori Break” is finished.
- 2.2.8 R2 will enter the Lagori Area and start piling up the Lagori.
- 2.2.9 If R2 displaces Ball on Head by itself, the team must retry.
- 2.2.10 The Round is finished when one of the following conditions is met:
 - ① When all the broken Lagori discs are piled up.
 - ② When the Hitter Ball thrown by the Hitter R1 hits the Ball on Head or the pipe or plate of the Ball on Head and the Ball on Head is displaced.
 - * “Displace Ball on Head” means that the ball is in the state of being separated from the top surface of the pipe.
 - ③ When 90 seconds have passed from the start of the Round.The referee will give signals at the time of ①/②/③ completion.

Hitter R1

- 2.2.11 The task of Hitter R1 is to throw the balls to the Ball on Head of Seeker R2. R1 can also pick up Hitter Balls from Ball Areas.
- 2.2.12 After the ‘Lagori Break’ is finished, R1 can leave the R1SZ to pick up the Hitter Balls.
- 2.2.13 The Hitter R1 can pick up Hitter Balls from the Ball Areas or receive them from R2. When R1 receives a ball from R2, the ball should not touch the field surface. Once the ball touches the field, the ball cannot be used again.
- 2.2.14 Once R1 has the Hitter Balls, it can throw them from the R1SZ to the Ball on Head of the Seeker R2.
- 2.2.15 While throwing Hitter Balls, R1 must not leave R1SZ. It must not extend into the space outside.
- 2.2.16 The Hitter Ball can be thrown, only one at a time. It can throw balls continuously, one after the other.
- 2.2.17 If Hitter throws the Hitter Balls to hit the Lagori discs piled up on the base and the Lagori discs are broken, the Round is finished, and Seeker’s “Lagori Pile” is considered to be achieved.
 - The same points will be added, as all the Lagori discs (that the Seeker has broken during the Lagori Break) piled up.
- 2.2.18 If the Hitter Ball thrown by Hitter R1 hits any part other than the plate and the pipe of Seeker R2 and the Ball on Head is displaced, the Hitter will be forced to retry and cannot restart for 15 seconds. Meanwhile, the Seeker team members should stop the Seeker R2 and enter the field and reset Ball on Head.
- 2.2.19 Hitter Balls must not hit the Lagori discs intentionally.
- 2.2.20 R1 can throw up to 6 Hitter Balls before the end of the Round.
- 2.2.21 Once thrown, Hitter Balls are not allowed to be reused.

Hitter R2

- 2.2.22 Hitter R2 can pick up Hitter Balls from the Ball Areas and pass them to Hitter R1 without touching the field surface.
- 2.2.23 R2 must not throw Hitter Balls at the Ball on Head.

2.3 Scores

- 2.3.1 Lagori Break
 - Seeker gets 5 points for each Lagori disc broken. The team can earn up to 25 points.
- 2.3.2 Lagori Pile
 - Seeker gets 10 points for each Lagori disc piled up. The team can earn up to 50 points.

2.4 Deciding the winner

At the end of the game, the winner will be decided in the following order:

- a) The team with the highest total score.
- b) If there is a tie, the winner will be decided in the following order:
 - i The team that displaced the opponent's Ball on Head
 - ii The team with a shorter time from the start of the Round until the completion of the 'Lagori Pile (including Perfect Lagori)'
 - iii Team with a higher score of "Lagori Pile."
 - iv To be decided by the judges

2.5 Retry

- 2.5.1 If needed the team can apply for a retry. Retrying can only be done with the permission of the referee.
- 2.5.2 If the robot violates the rules, the robot will be forced to retry according to the referee's instructions.
- 2.5.3. When retrying, both robots of the team must return to their respective SZs and restart.
- 2.5.4 The starting place of retry of each robot is their respective SZ.
- 2.5.5 During the retry, team members can adjust and change the position of the Balls mounted on the robots.
- 2.5.6 During the retry, team members cannot pick up the used Seeker Balls and Hitter Balls.
- 2.5.7 Team members cannot touch Lagori during the retry. However, it is allowed only if the robot cannot restart without touching the Lagori.
- 2.5.8 If it is unavoidable to touch the Lagori, the Lagori will be returned to the Lagori area according to the referee's instructions.
- 2.5.9 There is no limit to the number of retries. Retry must be done according to this Rulebook with the approval of the referee.

3. Robots

- 3.1 Each robot cannot be split into sub-units or connected by flexible cords during the game. The robots are not allowed to suction or to stick on the game field.
- 3.2 The robots in the contest must be built by team members from the same university or college, or polytechnics.
- 3.3 Teams are not allowed to bring or set up any equipment around the field, except robots and spare parts used in the game and some tools/devices used in setting time.
- 3.4 Robot Size
 - 3.4.1 At the game beginning, each robot must be less than 1,000 mm in length and 1,000 mm in width.
 - 3.4.2 There is no height limit for both teams' R1. The height of both teams' R2 must always be lower than the top surface of the Ball on Head plate (1,200 mm-1,250 mm).
 - 3.4.3 When cables are used to control a robot, the length of the cable is unlimited. However, the teams should be careful to avoid cable winding with the field facilities and game objects.
 - 3.4.4 Both for wireless or cable operation, the team members are not allowed to enter the Lagori Area and Ball Areas.

3.5 Weight of Robots

The total weight of two robots, controllers, the primary set of batteries used in the game must not exceed 50 kg. Any other equipment that the team brings for setup purposes, tools, air

containers, and backup batteries (of the same type as that initially installed in the robot) are exempt.

3.6 Power Source of Robots

3.6.1 Each team shall prepare its own power source.

3.6.2 Teams can use only batteries, compressed air, and/or elastic force as power source.

3.6.3 The nominal voltage of any battery used in the robot, controller, and any other devices during the game shall not exceed 24V. However, when connecting batteries in series, the total voltage must be 24V or less.

3.6.4 Measured voltage should be set to 42V or less by actual measurement. If the power supply system includes multiple isolated circuits, voltage in each system must be 42V or less.

3.6.5 Teams using compressed air must use either a container made for the purpose or a plastic bottle in pristine condition prepared appropriately. Air pressure must not exceed 600 kPa.

3.6.6 Any power source deemed dangerous may be banned from use.

3.7 Communication

3.7.1 Two robots in a team are permitted to cooperate and communicate with each other to complete the task.

3.7.2 For radio frequency communication, teams are only permitted to use Wi-Fi (IEEE 802.11), Zigbee (IEEE 802.15), and Bluetooth for the communications between controller and robot and between two robots. The organizer will not control the environment of Wi-Fi, Zigbee or Bluetooth.

3.7.3 During the test run before the contest, referees, will inspect the robots. Robots that do not meet the above requirements will not be allowed to participate in the game.

4. Violations

The team will be subjected to a compulsory retry for each violation and such retry does not affect the opponent team. Following actions are considered a violation:

4.1 Any team member touches any part of a robot, except the controller of the manual robot and in situations this Rulebook permits.

4.2 Any robot enters the prohibited areas and zone and extends into the space above them.

4.3 A part of the robot stays in the Penalty Zone, including the space above for 10 seconds or more.

4.4 Any robot made flying start without waiting for the referee's permission after Lagori Break.

5. Disqualifications

A team will be disqualified if it takes any of the following actions during the game:

5.1 The design and build of the robot are not following the rulebook.

5.2 The team intentionally damages or tries to damage the field, facilities, game objects or opponent's robots. Mainly when it is judged that Hitter R1 is aiming at a part of the opponent's robot instead of Ball on Head (BH), the team will be disqualified.

5.3 The team performs any acts that are not in the spirit of fair play.

5.4 The team fails to obey instructions or warnings issued by referees.

6. Safety

The design and build of robots should not pose any kind of danger to any person at the competition scene.

- 6.1 All robots must be designed and built to cause no damage to any robots of the opposing team or the field.
- 6.2 Attach an actual emergency stop button on the robot. A real visible emergency stop button is to be connected to each of the robots to enable one to shut down the robot in case of loss of control at any time.
- 6.3 Team members must wear running shoes, helmets, and safety goggles during the games and test runs.
- 6.4 The use of explosives, fire, or dangerous chemicals is prohibited.
- 6.5 Accumulators, lead-acid batteries are not allowed.
- 6.6 In designing and using the laser or infrared beams, full care must be taken to protect all persons at the venue from harm during all procedures. In particular, the beams must be so oriented that they cannot shine into the spectators' eyes.
- 6.7 If the laser is used, it must be of class 2 or less.
- 6.8 When using radio for signal transmission, teams must design systems, circuits, and mechanisms and ensure they do not go out of control and/or move dangerously even if a short circuit occurs or a connection is broken.
- 6.9 When teams have multiple power supply systems, teams must design the circuits and mechanisms not to go out of control or move dangerously no matter which power supply is lost or regardless of the order of turning on the power.
- 6.10 To avoid starting a fire or smoking by the overload of a motor stall and so on, proper current limiting devices such as a circuit breaker must be installed to power supply circuits.
- 6.11 Use wires, connectors, terminals, etc., with a rated current equal to or higher than the assumed maximum current.

7. Teams

- 7.1 Only one (1) representing the team from each country shall participate in ABU Robocon 2022 New Delhi, India. As the host country, India may be represented by two teams.
- 7.2 Each team consists of three (3) students (called team members), and one (1) instructor. They all belong to the same college, university, or polytechnic. The three students of the team are entitled to participate in the game.
- 7.3 In addition to three (3) team members, an additional three (3) student members are allowed to register as the pit crews and to assist in the pit area, to carry the robots to the field, and participate in the setting of the robots. They must be students of the same college, university or polytechnic as the team.
- 7.4 Students who have completed an academic program/graduate school are not permitted to participate. Team members must be bonafide students of the institution that their team represents.

8. Others

- 8.1 The legitimacy of any actions not mentioned in this Rulebook is subject to the discretion of the referee and judges.
- 8.2 The dimensions, weights, etc., of the field, facilities, and equipment described in this Rulebook have an error margin of $\pm 5\%$ unless otherwise stated. However, the dimensions and weights of the robots shown in the Rulebook are the maximum and cannot be tolerated.
- 8.3 All questions should be addressed to the official website of the ABU Asia-Pacific Robot Contest 2022, <http://www.aburobocon2022.com>. Notification of any additions and/or corrections to this Rulebook are made on the official website.

9. Domestic Contest in Each Country













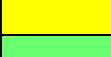

All domestic contests (in each country and/or region to select the representative team to participate in ABU Robocon 2022) should conform to the rules in this Rulebook. It is known that several materials and other facilities may not be available in some regions/places. The domestic organizers are advised to use the best possible facilities (i.e., game field and others) and objects as good and as close as possible to those set out in this Rulebook.

10. Transporting the Robots

- 10.1 The robots must fit inside a single crate with the inside dimension of (Length 1,800 mm \times Width 1,000 mm \times Height 800 mm) for transport. Only one box can be used. The weight of the crate, including the robots, must not exceed 240 kilograms.
- 10.2 For ABU Robocon 2022, the crates containing the robots, etc., will be picked up in late July 2022. Participants should consider this when preparing for the contest.

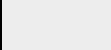
Appendix

Materials and colors of the game field, facilities, and objects.

Item		Color	R	G	B	Material
Red Area			255	129	118	Plywood, Water Paint
Blue Area			143	231	255	
R1/R2 Start Zone	Red Zone R1		255	20	3	
	Red Zone R2		255	255	0	
	Blue Zone R1		11	38	245	
	Blue team R2		255	255	0	
Ball Area			107	255	112	
Ball Rack			178	178	178	
Lagori Base			237	237	237	
Fence			245	121	43	
Lagori Area			255	255	0	
Lagori Disc	Red		255	20	3	Polyurethane Foam
	Blue		25	52	250	
Penalty Zone			237	237	237	Plywood, Water Paint